

**PCR-300
PCR-300 RC**

**Installation and Operating
Instructions**

Electronic refrigeration control

TABLE OF CONTENTS

1 Unpacking the unit and conditions of use	3
2 General instructions	3
3 Use and function	3
3.1 Use for the purpose intended	3
3.2 Function	4
4 Safety	4
4.1 Sources of danger	4
4.2 Safety precautions	5
5 Installation and commissioning	5
5.1 Mechanical installation	5
5.2 Electrical installation	6
5.3 Setting the DIP switch for the emergency setpoint and clock back-up battery	8
6 Operating of the controller	9
6.1 Switching on the operating voltage	9
6.2 Display	9
6.3 Key functions	10
6.4 Adjusting the cold store temperature	11
6.5 Changing the cold store temperature difference, defrost cycle, and alarm temperature	11
6.6 Setting the time (PCR-300RC only)	11
6.7 Manual defrost	12
7 Programming	13
7.1 Input parameters and ranges	13
7.2 Sensor calibration (parameters E 15 and E 16)	15
8 Maintenance	16
9 Alarm messages	16
10 Problem solving	17
11 Conditions of warranty	17
12 Technical data	18

1 Unpacking the unit and conditions of use

Before and when unpacking the unit, make a visual inspection to identify any possible damage which may have occurred during transportation. Please look for loose parts, dents, scratches, etc.

Report any damage immediately to the freight company. (Please see "Conditions if damage has occurred".) In other cases, the latest edition of the "General conditions for the supply of goods and services" issued by the ZVEI (German Central Association for the Electrotechnical Industry) shall apply.

Before disposing of the packaging, please check it for loose functional parts and information leaflets.

So that we can process warranty claims, please give an exact description of the defect (with a photograph, if appropriate) and state the model designation of the unit.

Please keep these operating instructions at the place where the equipment is used.

2 General instructions

Work on the electrical devices and switching equipment may only be carried out by appropriately qualified personnel. The relevant safety and environmental regulations must be followed.

FLICA equipment is free from PCBs, PCTs, asbestos, formaldehyde, cadmium and water-repelling substances.

The design of the equipment has taken into account the Standards EN 50081-1,2 (emitted interference), EN 50082-1 (immunity to interference), EN 60335-1 (electrical safety), IEC 695-2-1 to -2-3 (fire resistance, glow-wire test).

Safety tests have been performed in the factory on all equipment in accordance with EN 60335-1 (DIN VDE 0700 T500).

3 Use and Function

3.1 Use for the purpose intended

- This controller is designed to control ambient and media temperatures in cold stores and refrigeration systems and to control existing defrost equipment for one refrigeration circuit in each case.

- The controller must not be used as a safety cut-out device or excess temperature limiter.

If the controller is used for purposes other than those stated here, it shall not be considered to be use for the purpose intended.

- Only connect sensors supplied with the unit. If a replacement sensor is required, only use sensors of the same type (part no. H61007).
- The controller is **not** intended for use in vehicles because the possible operating voltage ranges, interference level and environmental operating conditions exceed the limits for which the controller can be used.
- Please take the application limits into account (see Technical Data, chapter 12).

3.2 Function

The PCR-300 is a microprocessor-controlled cold store control for refrigeration and deepfreeze systems with a modular housing for installation on 35 mm standard rails.

- Compressor control (dependent upon cold store temperature) with delayed start-up.
- Evaporator fan control
 - Fan either in combination with compressor or
 - operating continuously or
 - switched via the evaporator thermostat.
- Defrost control limited thermostatically, either for electrical heating or hot-gas defrosting
- Alarm output.

Defrosting is initiated via programmable intervals of time, max. 24/day.

The **PCR-300 RC** is provided with a real-time clock with a back-up battery for defrost control. A maximum of six times per day can be programmed.

4 Safety



4.1 Sources of danger

- Caution - Mains voltage.
- Never expose the unit to water or moisture. Risk of malfunction and short circuit. Only use the unit when it is adjusted to normal ambient temperature (+15 to +30 °C). Extreme changes in temperature in combination with high atmospheric humidity may lead to the formation of condensed water.
- Even if the control-circuit voltage is switched off, high voltage may still be applied to the unit. For this reason, **isolate all electric circuits before starting any service work.**

- Never expose the unit to excessive heat, dust and vibrations. Avoid knocks and pressure loads. If the housing is damaged, there is a risk of an electric shock causing death or injury.
- If the unit cannot be operated without the risk of danger, it must be taken out of service and precautions taken so that it cannot be switched on again unintentionally.

This applies, in particular, if:

⇒ The housing has damage which is visible,

⇒ the unit is no longer operational or

⇒ it has been stored for a long time in unfavourable conditions.

- The unit must not be opened. If it is thought that the unit may be defective, send it back to the dealer or manufacturer with a precise description of the fault.



4.2 Safety precautions

- All electromagnetic loads (solenoid valves, contactors, alarm horns, motors) should be interference suppressed directly at the coil with RC elements.
- Please note the maximum contact rating of the relays and terminals.

If this is not observed, there is a risk that the contacts may pit or stick, with the result that the refrigeration system will not operate correctly and the refrigerated items may be damaged.

- Sensor leads are to be routed separately from mains voltage wires. The clearance should be at least 5 cm.
- Sensor leads must not be routed in multiple cables with other leads carrying mains voltage, otherwise the system may malfunction.
- Tighten the terminals carefully; excessive strain will result in damage to the controller.
- **PCR-300RC:** Set DIP switch 2 to "off" if the controller is going to be out of service for more than 3 months and when the controller is shipped. This is to prevent damage occurring to the back-up battery.

5 Installation and commissioning

5.1 Mechanical installation

- **4 Din standard modular housings to be mounted on a standard rail:**

a) housing with 2 mounting tabs:

open out the lateral mounting tabs; clip the unit on the 35 mm rail and press tabs in again.

b) housings with 1 mounting tab:

put housing on the upper 35 mm rail. Clip the unit on the 35 mm rail, lower tab clips on the rail automatically. To remove the unit from the rail press in lower mounting tab with a screw driver, lift unit.

● **Mounting of sensor:**

- Use a cable clamp to secure sensor T1 in a suitable position.
- Secure evaporator sensor T2 in the evaporator fin core at the point where it is suspected icing is the greatest. It is advisable to use a point in the lower third of the finned evaporator.

5.2 Electrical installation



⚡ **CAUTION:** The mains voltage and system frequency must be the same as the nominal values on the device's rating plate.

Work on electrical systems must be performed by qualified personnel. Relevant local safety regulations must be observed.

Wiring diagram:

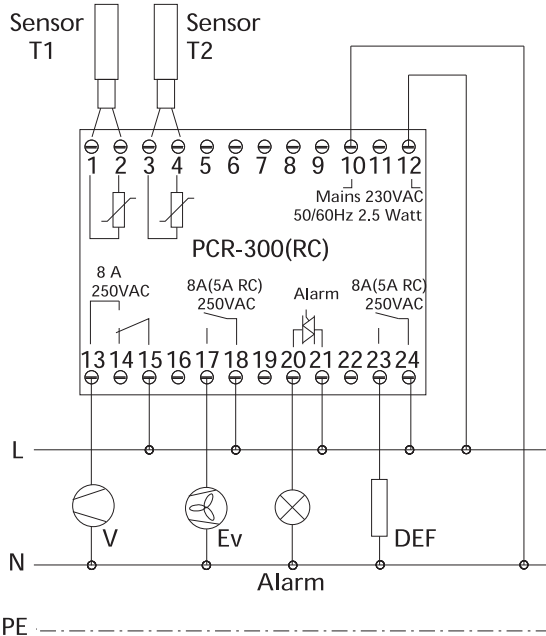

Terminal:	Description:
1 - 2	T1 = Cold store sensor
3 - 4	T2 = Evaporator sensor
10 - 12	Mains = Power supply
13 - 15	V = Compressor contactor (cooling)
17 - 18	Ev = Evaporator fan (contactor)
20 - 21	Alarm = Remote alarm indicator; indicator lamp or contactor (with RC-element)
23 - 24	Def = Defrost heating (contactor) or hot gas valve

☛ **The unit is equipped with an opto-decoupled electronic alarm output.**

Take note of the alarm output limit values.

- Supply voltage: Max. 250 V AC.
- Minimum load: 40 mA
- Maximum load: 80 mA
- If an inductive load (contactor or horn) is connected, connect an RC element directly at its coil.

☛ **Instructions:**

- Pay attention to the contact loading of the relay (8A / 5A resistive load, 2A / 1A inductive load). As a general rule, contactors are recommended.
- The maximum tested sensor cable length is 50 m, with a minimum cross section of 2 x 0.75 mm². Solder the extension cable to the sensor cable to prevent contact resistances.
- It is advisable to use shielded sensor extension cables. All shields must be routed at the side of the controller to **one** earth/protective potential. The extension cable shield must not be connected on the sensor side, otherwise bonding currents may occur via the shielding.
- The controllers are designed respecting the highest degree of immunity to interference. If the local interference level exceeds the immunity data might get lost (AL1 in display) and the controller switches to the preprogrammed setting values. This is not a malfunction of the controller. In such cases the means to suppress interference have to be improved (RC-elements, shielded lines).

5.3 Setting the DIP switch for the emergency setpoint and the clock back-up battery

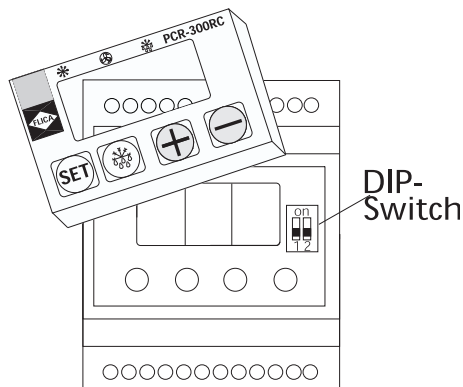

Carefully lift the housing cover off the side, using your fingers.

- **Selection of the emergency setpoint** for the cold store temperature:

This will be activated if the data in the memory is lost and alarm AL1 is activated. This sets all program parameters to the preset value. The cold store temperature setpoint can be preset to +4 °C or -18 °C, as desired. This ensures that chilling systems with temperatures above zero do not freeze and deepfreeze installations do not thaw.

DIP switch 1 (left), Pos.: **off** (bottom): Setpoint value at +4 °C for emergency operation.
Advisable for chilled storage (= Preset value).

Pos.: **on** (top): Setpoint value at -18 °C for emergency operation.
Advisable for deepfreezers.

For PCR-300 RC only:

The back-up battery must be switched on when the controller is started up so that the real-time clock keeps operating if there is a power failure.

Activation of the back-up battery:

DIP switch 2 (right), Pos.: **off** (bottom): Battery switched off when controller is stored or in transit. (The battery is switched off when the controller is delivered; exhaustive discharge monitoring).

Pos.: **on** (top): Battery activated.

☛ **Note:** It takes approximately 24 hours for the battery to achieve its full back-up capacity.

The battery will provide cover for a power failure of approximately 1 month.

6 Operation of the controller

Front view of controller:

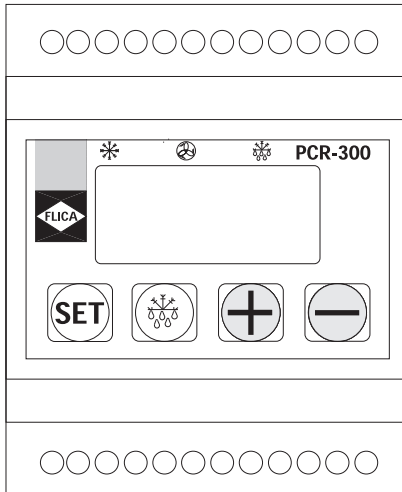

6.1 Switching on the operating voltage

The controller is started by means of a control switch provided by the customer.

The first time the controller is started, pre-programmed setting values are used which at later point can be adapted for individual requirements.

If alarm "AL 2" (temperature in refrigerated chamber too high or too low) is displayed when the controller is switched on, this can be cleared by pressing the  key.

6.2 Display

During normal operation the current cold store temperature is displayed. It is measured with cold store sensor T1.

In the event of an alarm, the most recent alarm message (e.g. **AL1**) and the cold store temperature are displayed alternately.

Three spot indicators show the switching status of the relays during operation:

Pos. 1: On : Compressor relay on.

Off: Compressor relay off.

Flashes: Compressor start-up delay E05 active.

Pos. 2: On : Evaporator fan relay on.

Off: Evaporator fan relay off.

Pos. 3: On : Defrost relay on.

Off: Defrost relay off.

Flashes: Drain time E09 is running.

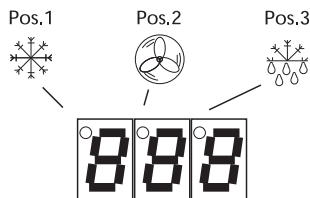

6.3 Key functions

⚠ Never operate the keys with sharp objects (screwdriver or similar).

Display of setpoint temperature	Press and hold down key.
Clear alarm messages	Press key. (If the sensor is faulty, switch mains voltage ON/OFF.)
Evaporator temperature display	Press and keys in sequence and hold both down.
Manual defrost initiation	Press key for 5 secs.
Display of time until the next defrost	Press and keys in sequence and hold both down. (Display in hours and minutes.)
Display limit value for excess temperature alarm (cold store sensor T1)	Press key.

- Change input values by using the and keys with the key pressed down.
- Input parameters, e.g. the switching difference, are indicated by "E" and a 2-digit number, e.g. "E01".
- The input parameters are grouped together in two programming levels.

- **Access the first programming level** by pressing the \oplus and \ominus keys at the same time for 5 seconds.
 - Then use the \oplus and \ominus keys to access the parameters to be changed.
 - **Access the second programming level** by pressing the \oplus and \ominus and \otimes keys simultaneously for 5 seconds.
- To exit from the programming levels and save the data, press the \oplus key after the last input parameter. If no key is pressed in either of the programming levels for 10 minutes, this mode will be exited without the data being saved.
 - Do not display altered parameter data before saving the data, as it would be reversed to its original value in the process.

6.4 Setting the cold store temperature

Press and hold down the SET key. Adjust the setpoint for the value in question using the \oplus or \ominus key.

Adjustment is possible within the limits of the input parameters E12 and E13.

The factory setting is +4 °C.

6.5 Changing the cold store temperature difference, defrost cycle and alarm temperature

Access to the first programming level:

- Press and hold down the \ominus and \oplus keys at the same time for approx. 5 seconds (E01 appears in the display for PCR-300 and E00 for PCR-300RC)
- Setting: Press and hold down the SET key. Adjust the setpoint value to the desired figure using the \oplus or \ominus key.

Input parameters and input ranges:

Display		Setting range	Preset
E00	Time, for PCR-300RC only	0.00 to 23.5, see section 6.6	12'0
E01	Cold store temp. difference	1 to 20 K	2 K
E02	Time between 2 defrost cycles	1 to 24 h	8 hours
E03	Alarm temperature difference	-50 K to +50 K	20 K

If the set temperature difference E03 is negative, an alarm is given if it is too cold in the refrigerated area,
 e.g. E03 = -10 K, cold store setpoint = -18 °C
 → alarm at -28 °C in refrigerated area.

If the set temperature difference E03 is positive, the alarm is given if it is too warm in the refrigerated area,
 e.g. E03 = +10 K, cold store setpoint value = -18 °C
 → alarm at -8 °C in the refrigerated area.

Attention: any change of the cold store setpoint valve changes also the alarm temperature.

If E03 is set to 0, no alarm will be given.

PCR-300RC only:





E2'1	1st defrost time	--- (none), 00.1 to 23.5 hours	--- (none)
E2'2	2st defrost time	--- (none), 00.1 to 23.5 hours	01'0 hours
E2'3	3st defrost time	--- (none), 00.1 to 23.5 hours	07'0 hours
E2'4	4st defrost time	--- (none), 00.1 to 23.5 hours	13'0 hours
E2'5	5st defrost time	--- (none), 00.1 to 23.5 hours	19'0 hours
E2'6	6st defrost time	--- (none), 00.1 to 23.5 hours	--- (none)

The time is entered in increments
 of 10 minutes in each case.

Caution: The times must be entered
 in ascending order.

Exiting programming mode: Press the  key after the last level has been entered.

6.6 Setting the time (PCR-300RC only)

- Press and hold down the  and  keys at the same time for approx. 5 seconds to access the first programming level (Display: **E00**).
- Setting: Press and hold down the  key and change the time to the current time using the  or  key (increments of 10 minutes).

Display	Setting range	Preset
E00 Time	00.0 to 23.5 hours	12'0 hours

Exiting programming mode:









Press the  key several times.

6.7 Manual defrosting





Press and hold down the  key for 5 seconds.
The manual defrosting process will be initiated.

7 Programming

Access to the second programming level:

- Press and hold down the ,  and  keys at the same time for approx. 5 seconds
(Display: **E01** for PCR-300, **E00** for PCR-300RC).
- Use  or  key to select parameters.
- Setting: Press and hold down the  key. Adjust the setpoint value to the desired figure using the  or  key.
- Do not display altered parameter data before saving the data, as it would be reversed to its original value in the process.

7.1 Input parameters and input ranges

Parameter in Display ( or )	Setting range ( and  or )	Preset	
E00	Time, only for PCR-300RC	00.0 to 23.5 hours	12'0 hours
E01	Cold store temp. difference	1 to 20 K	2 K
E02	Time between 2 defrost cycles	1 to 24 hours	8 h

- ☛ **Once the controller has been switched on, defrosting occurs for the first time at the end of the first time interval.**
- ☛ **After defrosting has been initiated manually, the next time defrosting takes place is after a complete time interval has elapsed.**
- ☛ **If the time interval between two defrost cycles is changed when the system is in operation, the new time interval will not be applied until after the next time defrosting has occurred.**

For PCR-300RC only:

E2'1	1st defrost time	--- (none), 00.1 to 23.5 hours	--- (none)
E2'2	2st defrost time	--- (none), 00.1 to 23.5 hours	01'0 hours
E2'3	3st defrost time	--- (none), 00.1 to 23.5 hours	07'0 hours
E2'4	4st defrost time	--- (none), 00.1 to 23.5 hours	13'0 hours
E2'5	5st defrost time	--- (none), 00.1 to 23.5 hours	19'0 hours
E2'6	6st defrost time	--- (none), 00.1 to 23.5 hours	--- (none)

The time is entered in increments
of 10 minutes in each case .

**Important: The times must be entered
in ascending order.**

E03	Alarm temperature difference	-50 K to + 50 K	20 K
E04	Delay time – Alarm	0 to 99 mins.	10 mins.
E05	Compressor start-up delay	0 to 15 mins.	5 mins.
E06	Defrost type 1 = Electrical (compressor off) 2 = Hot gas (compressor on)	1 or 2	1
E07	Defrost limit temperature	0 to 50 °C	8 °C
E08	Defrost time limit	1 to 99 mins.	25 mins.
E09	Drainage time, evaporator	0 to 99 mins.	3 mins.
E10	Time delay, fan	0 to 500 secs.	30 secs.
E11	Evaporator fan control 1 = Fan with compressor. 2 = Continuous fan operation, except during defrosting. 3 = Fan run-on. If there is an undershoot in the cold store temperature, the fan is switched on by evaporator sensor T2. The fan is switched off again once the desired cold store temperature is attained or exceeded.	1,2 or 3	1

E12	Minimum permissible cold store temp.	-55 °C to E13	-55 °C
E13	Maximum permissible cold store temp.	E12 to +50 °C	+50 °C
E14	Display during defrosting 1 = "dEF" in display. 2 = Current cold store temperature in display. 3 = Retaining temperature in display when defrosting is initiated until the current cold store temperature reaches the retained value again. This is for a maximum of 15 minutes after the end of defrosting.	1,2 or 3	1

☛ **Evaporator drainage time E09 and time delay fan E10 are not respected at hot gas defrost mode E06 = 2.**

E15	Sensor calibration T1 (cold store)	-5 to +5 K	0 K
E16	Sensor calibration T2 (evaporator)	-5 to +5 K	0 K
E17	Operation of compressor relay if cold store sensor T1 is defective	0 = Relay de-energizes 1 = Relay is permanently energized 2 = Alternately energized/de-energized according to time set in E18 and E19.	2
E18	"On" time at E17	1 to 99 mins.	15 mins.
E19	"Off" time at E17	1 to 99 mins.	15 mins.

To exit from the programming mode:

Press the  key after inputting the last level.

7.2 Sensor calibration (parameters E15 and E16)

The cold store and evaporator sensors can be calibrated.

Note: An additional resistance of 7 Ω in each case, caused by the extension of the sensor cable, results in a change in the temperature display by +1K.

How to proceed: Measure the temperature at the sensor concerned with a calibrated thermometer or submerge the sensor in well mixed iced water (0 °C).

Compare the measured temperature with the temperature displayed on the unit display.

If the measured temperature is lower than the one displayed, set the negative difference as the programming value (e.g. - 2 K).

If the measured temperature is higher than the one displayed, set the positive difference as the programming value (e.g. 2 K).

The temperature display is then corrected by the set value.

8 Maintenance

The controller does not require any maintenance. It does not have any fuses so, if brief voltage spikes occur, the refrigeration system will not stop operating for a prolonged period. Once the disturbance has passed, the controller will automatically start up again.

Cleaning the housing: Only a dry anti-static cloth may be used to wipe clean all plastic parts. Do not use water or cleaning agents containing solvents!

9 Alarm messages

If an alarm occurs, the alarm output will be activated and on the display a code will alternate with the cold store temperature.

Display	Meaning
AL1	Program memory data loss. The preset values will be used as an emergency program. The setpoint value will be set to +4 or -18 °C, depending on the selection of DIP switch 1.
AL2	Limit value (=setpoint value +E03) at sensor T1 exceeded and delay time E04 elapsed.
AL3	The sensor temperature at sensor T1 is above 50 °C or below -55 °C.
AL4	The specified setpoint value is outside the limits E12 and E13
AL5	Cold store temperature sensor T1 – short circuit or break in wiring. Compressor switches as a function of parameter E17.
AL6	Evaporator temperature sensor T2 – short circuit or break in wiring. Safety times are used, for the fan run-on function the fan is controlled with the compressor by the evaporator fan control E11 automatically switching from 3 to 1. ☛ After sensor T2 has been repaired, E11 must be reset manually from 1 to 3.
AL7	For PCR-300RC only: Real-time clock faulty, switching over to interval defrosting (interval = 4 hours)!

Clearing alarm:

Press the ⊕ key.

All alarm messages, with the exception of AL2, are also reset by switching off the operating voltage. AL2 can only be reset using the ⊕ key.

10 Problem solving

Fault	Cause	Remedy
Evaporator fan does not switch on during cooling when the programmed setting of parameter E11 is set to position 3 (fan run-on).	Evaporator sensor T2 has fallen out of the fins.	Refit sensor.
For PCR-300RC only: The real-time clock stops or indicates the wrong time in the event of a power failure.	Back-up battery is switched off.	Switch on back-up battery see Section 5.3.

11 Warranty conditions

- Warranty is provided for a period of 12 months, starting at the date the item was delivered. Proof of this should be furnished in the form of a delivery note or invoice.
- All functional faults caused by poor workmanship or faulty materials will be repaired free of charge during the warranty period.
- More extensive claims, in particular for consequential damage, are excluded
- Damage or malfunctioning caused by the equipment being handled incorrectly or by non-compliance with the operating instructions shall not be covered by the warranty.

The warranty shall be invalidated if any work is carried out on the appliance.

12 Technical data

Mains voltage/frequency	230 V AC \pm 10% / 50/60 Hz
Rated wattage	2.5 watts
Display	3-digit, 7-segment, red LED, 14.2 mm
Resolution	1 K
Measuring range	-55 to +50 °C
Outputs	1 relay with changeover contact, 8 A, 230 V AC, resistive load, (cooling). 1 relay with N.O. contact, 8 A (5A PCR-300RC), 230 V AC, resistive load, (defrost heating). 1 relay with N.O. contact, 8 A (5A -PCR-300RC), 230 V AC, resistive load (fan control).
Control response	Two-step
Alarm output	Opto bidirectional triode thyristor, 250 V AC, max. load 80mA
Display accuracy	\pm 0.5K internal, \pm 1 digit, at 25 °C
Operating conditions	0 °C to 50 °C, 30 to 85 % R.H., excluding dew
Storage temperature	-20 °C to +80 °C
Data back-up	Non-volatile memory (EEPROM) Clock: Back-up battery, approx. 1 month power reserve (PCR-300 RC only)
Emergency setpoint selection	DIP switch under display cover (off = +4 °C / on = -18 °C)
Sensor type	PTC
- Number	2 sensors T1 = Control signal to compressor relay T2 = Control signal to defrost limitation and fan control
- Cable length	2.5 m
- Range where cable can be used:	-30 °C to +80 °C not fixed -40 °C to +80 °C fixed
- Accuracy	\pm 2 %
Housing	L x W x H = 85 x 70 x 61 mm, ABS plastic, self-extinguishing (UL 94 V0)
Protective rating	Housing: IP 20, front panel: IP 52 Class of protection 2
Terminals	250V / 10 A screw-type terminal strips, with wire protection, tightening torque 0.6 Nm Max. core cross section 1.5 mm ²
Weight	Approx. 420 g (inc. 2 sensors).

Only operate the unit in dry places.

Errors in the technical data are excepted. We reserve the right to make changes without prior notice.

EC Declaration of Conformity

as defined in the
EMC Directives 89/336/EEC
and the
EC Low Voltage Directives 73/23/EEC

Product: **FLICA, electronic coldstore control**

Model designation: **PRC-300, PCR-300RC**

has been developed, designed and manufactured in accordance with the
EC Standards listed above.

The following harmonized Standards have been applied:

EN 50081-1 (1991)

Part 1 for the trades sector, emitted interference

EN 50081-2 (1993)

Part 1 for the industrial sector, emitted interference

EN 50082-1 (1991)

Part 1 for the trades sector, immunity to interference

EN 60335-1 (1993-03-09)

IEC 335-1 (1976) ed 2

Electrical safety, part 1: general requirements

EN 60730-1 (1992-12-09)

IEC 730-1 (1986) ed 1

Automatic electronic controls

Full technical documentation is available.

Operating instructions for the device are provided.

Mosbach, March 22nd, 1999

Honeywell Flica
Honeywell AG
Hardhofweg
D-74821 Mosbach



i.V. Dr. Osthues
R + D / Production Manager

Honeywell

Automation and Control Solutions

Honeywell GmbH

Hardhofweg • 74821 Mosbach / Germany

Phone: +49 (0) 62 61 / 81-475

Fax: +49 (0) 62 61 / 81-461

E-Mail: Cooling.Mosbach@honeywell.com

www.honeywell-cooling.com

Manufactured for and on behalf of the
Environment and Combustion Controls
Division of Honeywell Technologies Sàrl,
Ecublens, Route du Bois 37, Switzerland
by its authorised representative Honeywell GmbH